

**BUTTON FUNCTIONS FONCTIONS DES BOUTONS TASTENFUNKTIONEN
FUNZIONI DEI PULSANTI FUNCIONAMIENTO DE TECLAS**

How to use buttons Synoptique fonctionnel Tastenbedienung Come usare i pulsanti Funciones de las teclas

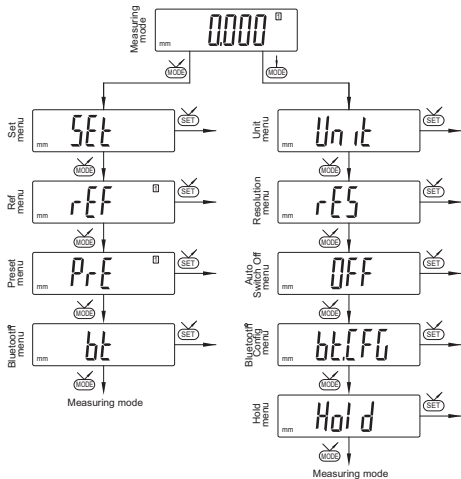

SET MODE MODE "SET" SET MODUS MODALITÀ SET MODO SET

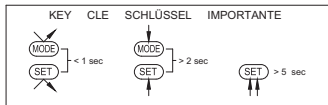
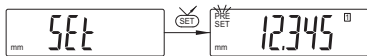

**ON / OFF MARCHÉ / ARRÊT EIN / AUS
ON / OFF ENCENDER / APAGAR**

Switch On

Activer
Einschalten
Accendere
Encender



Wake Up
Sortie du mode "veille"

Aufwachen
Sveglia
Despertarse

Switch Off
Désactiver
Aussschalten
Spegnere
Apagar



Standby / Veille / Bereitschaft
En espera

Off / Désactivé / Aus / Spento
Apagado

**REFERENCE MODE MODE "REFERENCE" REFERENZ MODUS
MODALITÀ RIFERIMENTO MODO REFERENCIA**

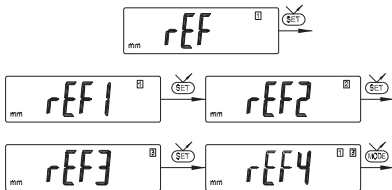

RESOLUTION RESOLUTION AUFLÖSUNG RISOLUZIONE RESOLUCIÓN

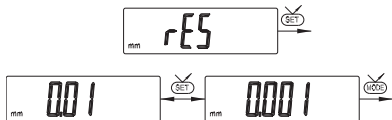

PRESET MODE
MODALITA' PRESET

MODE "PRESET"
MODO PRESET

PRESET MODUS

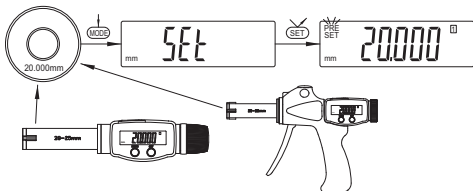
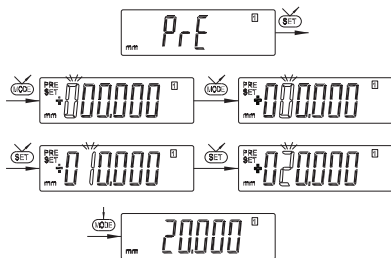

UNIT UNITE MESSEINHEIT UNITÁ UNIDAD

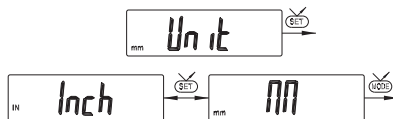

BLUETOOTH® MODE
MODALITÀ BLUETOOTH®

MODE "BLUETOOTH®"
MODO BLUETOOTH®

BLUETOOTH® MODUS

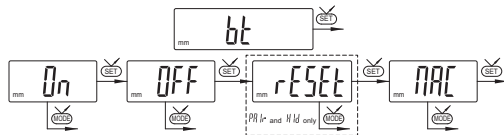

BLUETOOTH® CONFIGURATION

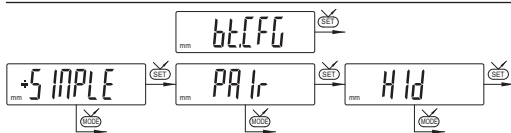

From Firmware r4.07

S IMPL : Default profile, without pairing. No security requirements, compatible with most existing applications.

PAIR : Paired and secured profile. Uses an encrypted connection to read or write values.

Hid : Bluetooth® keyboard emulation. Connect and use with any Bluetooth® 4.0 capable device.

Previous Bowers Bluetooth® enabled devices always use paired profile.

Note: Bluetooth® pairing information is cleared when the profile is changed.

CONNECTION PROCEDURE

Symbol \rightarrow off.....disconnected mode

Symbol \rightarrow blinking.....advertising mode

Symbol \rightarrow on.....connected mode

rESEt - Clear pairing information
MAC - Display the MAC address

1. Activate Bluetooth® compatible software and hardware (Master : PC, Display Unit).
2. Start the instrument. By default the Bluetooth® module is active and the instrument is available for connection (advertising mode).
3. If no connection is established during the advertisement period reactivate the Bluetooth® module using the **bt / On** menu.
4. Instrument is ready to communicate (connected mode).

Only with paired profile:

Pairing with master is automatically done at first connection.

To connect the instrument to a new master (new pairing), pairing information on the instrument must be cleared using the **bt / rESEt** menu.