

# LABCONCEPT Nano



# LABCONCEPT Nano

## INTRODUCTION

### No compromise on accuracy

The Labconcept Nano is a new reference in the field of dimensional metrology. It integrates 40 years of knowledge and continuous improvement. It is a remarkable instrument for all measuring tasks that require extremely high accuracy.

The uncompromising design of the Labconcept Nano offers an ideal and performing platform for checking and calibration of all kinds of gauges and measuring instruments. Checking of internal and external dimensions will be done as a fully automatic procedure by the three motorized axes XYZ and the legendary simplicity of use of Trimos WinDHI software.

The Labconcept Nano is completely designed and manufactured in Switzerland according to the highest quality standards. Robustness, reliability and longevity are our traditional values.

### A New Technological Dimension

The Labconcept Nano combines tradition, experience and a strong technological lead. It integrates the latest measuring and motorisation technologies and can be considered as the first "full digital" calibration instrument. A regular PC controls all electronic components. This low-power solution avoids heating and keeps the energy, maintenance and repair costs at a reasonable level. The linear bearings used in all guideways have proven their superiority over all other technologies in terms of precision, wear, rigidity, temperature stability, reliability, dust protection and maintenance. They ensure exceptional repeatability and precision through time.

---

UNEQUALLED HIGH LEVEL OF ACCURACY

---

EXCEPTIONAL REPEATABILITY

---

MOTORIZED MEASURING CARRIAGE, X AXIS, SELECTION OF SPEED BY SOFTWARE

---

MOTORIZED UNIVERSAL MEASURING TABLE, CNC Y AND Z AXIS WITH INTEGRATED MEASURING SYSTEM

---

MEASURING FORCE (0-12N) AND LOCKING OF MEASURING ANVIL PERFORMED BY SOFTWARE

---

INTEGRATED TEMPERATURE COMPENSATION SYSTEM

---

ABSOLUTE MEASURING RANGE ON ALL MODELS: 350 MM

---

APPLICATION RANGES OF 350, 600 AND 1100 MM

---

MEASURING OF PARTS UP TO 60 KG IN WEIGHT

---

2 SCREENS IN THE STANDARD PACKAGE

---

CNC CONTROLLED MEASUREMENTS EVEN ON DIAMETERS AND THREADS

## DESCRIPTION



motorized measuring  
table (YZ)

CNC controlled  
measuring carriage (X)

PC with 2 screens including  
WinDHI software for  
measurements and  
WinComp for temperature  
compensation

Ergonomic and  
compact Workbench

# LABCONCEPT Nano

## DISPLAY / SOFTWARE

### TRIMOS WINDHI NANO

Trimos Win DHI Nano is the exclusive measurement software of Trimos. It is part of the basic equipment of the Labconcept Nano and allows the performance of all measuring functions. It helps the user to perform all measurement tasks through a user-friendly interface.

The motorization of the measuring carriage (X) and both vertical (Z) and horizontal (Y) axis of the universal measuring table allow an exceptional performance in terms of measuring speed, ease of use and accuracy.

Positioning can be done easily using the mouse and the keyboard or via the touch screen (optional) or a joystick (optional). Once positioned, measurements are entirely CNC controlled, including searching the reversal point. Plug and ring gauges, threaded ring and plug gauges etc. can be measured automatically in a few seconds. No risk of damage to the sensitive probes while moving or measuring, even with tiny parts and inserts.

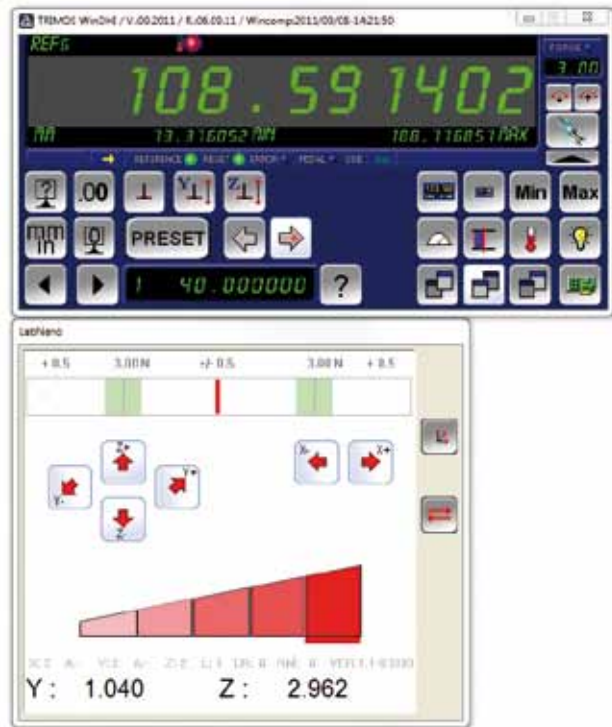

- 100 % AUTOMATIC MEASUREMENTS

---

- MEASUREMENTS PERFORMED IN A FEW SECONDS

---

- USER FRIENDLY INTERFACE

---

- GRAPHIC HELP FOR MEASURING FUNCTIONS

---

- ELECTRONICALLY ADJUSTABLE MEASURING FORCE

---

- DATA TRANSFER USING A FOOT SWITCH

---

- DDE SERVER (FOR EXCEL, WORD, ETC.)

### TRIMOS WINCOMP

The Labconcept Nano is equipped as standard with a temperature compensation system Trimos WinComp allowing the acquisition and management of temperature data.

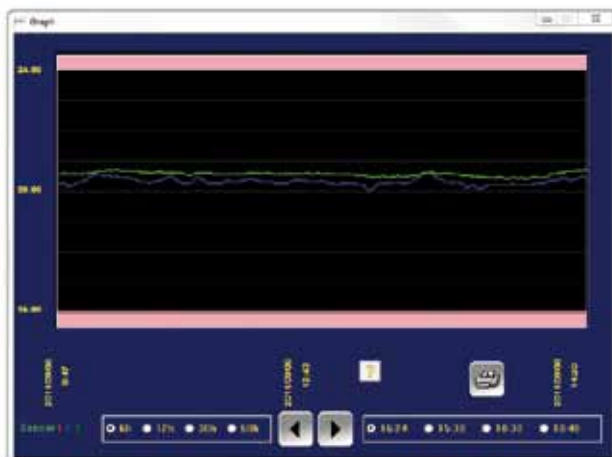

- TRIMOS WINCOMP EXCLUSIVE SOFTWARE

---

- ACQUISITION AND MANAGEMENT OF TEMPERATURE DATA

---

- PERMANENT CONNECTION WITH WIN DHI

---

- REAL - TIME COMPENSATION OF THE MEASUREMENT

---

- TEMPERATURE EVOLUTION HISTORY OVER SEVERAL YEARS FOR A PERFECT TRACEABILITY

---

- GRAPHICAL DISPLAY OF TEMPERATURE EVOLUTION

---

- MATERIALS LIBRARY

---

- INDICATION OF THE MEASUREMENT RELIABILITY LEVEL

## DISPLAY / SOFTWARE

### QMSOFT

Trimos recommends the QMSOFT software package for inspection and management of all measuring tools available.

INTEGRATED DRIVERS FOR TRIMOS INSTRUMENTS

REQUIRED NOMINAL SIZES AND TOLERANCES  
AVAILABLE ACCORDING TO ALL STANDARDS

CUSTOMIZED INSPECTION CERTIFICATES

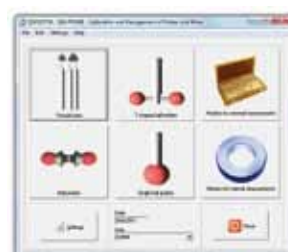

## TECHNICAL SPECIFICATIONS

Labconcept Nano		350	600	1100
Application range	mm (in)	350 (13.2)	600 (23.6)	1100 (43.3)
Absolute measuring range	mm (in)	350 (13.2)		
Max. permissible errors <sup>1)</sup>	µm	0.07+L(mm) / 2000		
Repeatability (2s) <sup>1)</sup>	µm	0.03		
Max. resolution	mm (in)	0.000001 (0.0000001)		
Measuring force (adjustable by software)	N	0 ÷ 12		
Operational temperature	°C	+15 ÷ +35		
Temperature of storage	°C	-10 ÷ +40		
Relative humidity	%	20 ÷ 80		
Weight	kg	350	420	500

<sup>1)</sup> Values valid at temperature of 20 ± 0.2 °C and relative humidity of 50 ± 5%.

Measuring table with motorized Y and Z axes		
Z axis, displacement range <sup>2)</sup>	mm (in)	100 (4)
Y axis, displacement range <sup>2)</sup>	mm (in)	50 (2)
X axis, floating movement	µm	± 10
Angle of inclination (Y)	°	± 1.5
Angle of rotation (Z)	°	± 4
Max. weight of parts	kg	60

<sup>2)</sup> Both axes Y and Z have an integrated measuring system.

# LABCONCEPT Nano

## SCHEMA

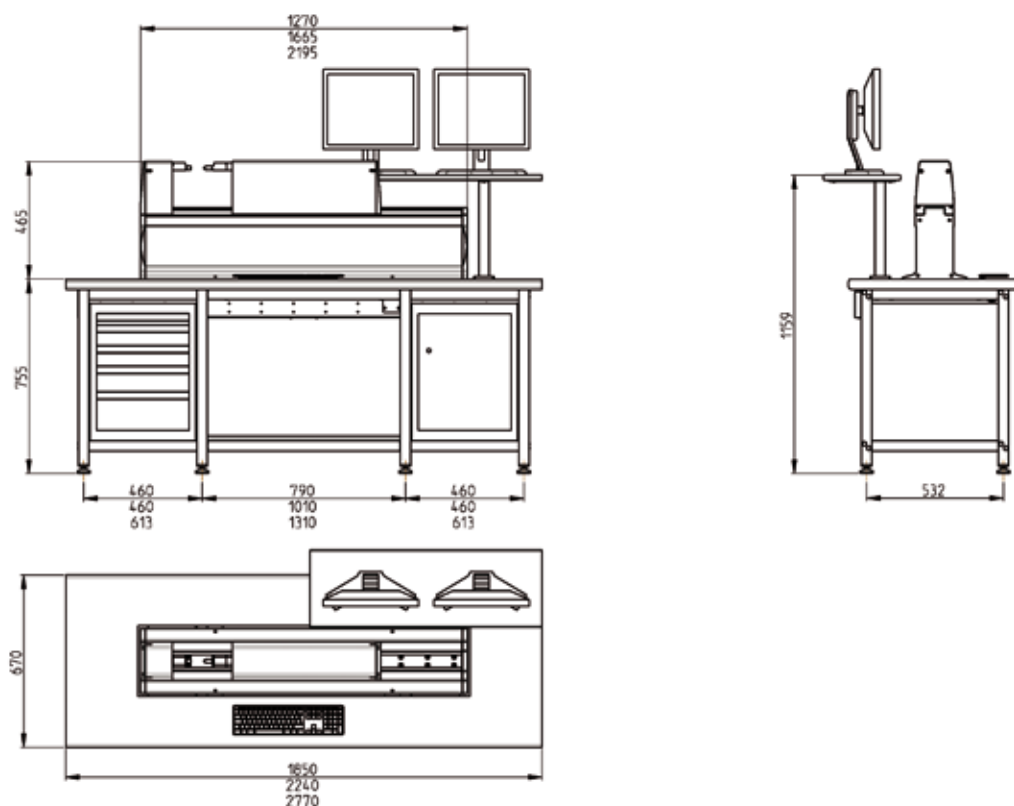

## STANDARD INSTRUMENT

**The Labconcept Nano are supplied as follows :**

- Instrument according to specifications with tungsten carbide surface anvils
- Universal measuring table with motorized Y and Z axes (Nano-14)
- PC with interface, 2 LCD TFT screens and 1 printer
- Foot pedal for data transfer (TELMA31)
- Specially designed workbench with 1 drawer cabinet and 1 door cabinet
- Temperature compensation system (TEMPCOMP-B)
- Lapping plate (TA-TO-302)
- Protection cover (TEL.HO500 / 1000 / 1500)
- Allen key set (TA-TO-004)
- User's manual (750 50 0039 03)
- Test certificate

## CODE NUMBERS

Labconcept Nano	Standard workbench	Anti-vibration workbench	
<b>LABC-NANO 350</b> 700 213 00 01	<b>TA-TO-306</b> 714 12 006	<b>TA-TO-310</b> 714 12 010	Measuring range 350 mm
<b>LABC-NANO 600</b> 700 213 10 01	<b>TA-TO-307</b> 714 12 007	<b>TA-TO-311</b> 714 12 011	Measuring range 600 mm
<b>LABC-NANO 1100</b> 700 213 20 01	<b>TA-TO-308</b> 714 12 008	<b>TA-TO-312</b> 714 12 012	Measuring range 1100 mm

## APPLICATIONS

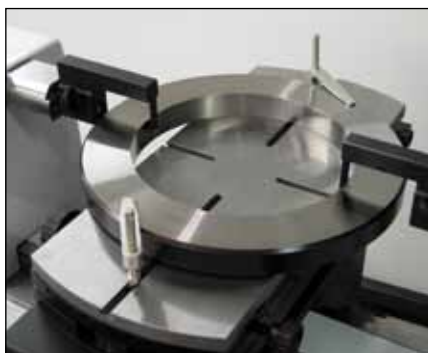

Calibration of plain ring gauges  
(TEL16.1/TA-SU-354)

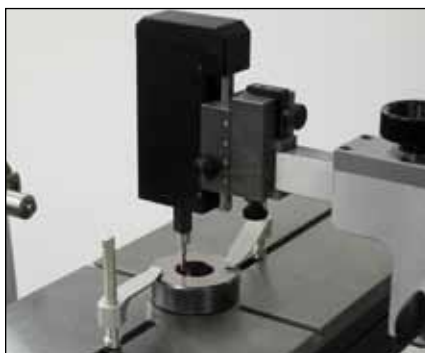

Calibration of small plain ring gauges  
(TA-MS-370/TEL76/TA-SU-354)



Calibration of thread ring gauges  
(TA-MS-370/TEL75/TA-SU-354)



Calibration of plug gauges  
(TULM6/L05/TA-SU-315)



Calibration of thread plug gauges  
(3P/0.17-3.2/S6.5/TA-SU-315)



Comparative checking of gauge blocks  
> 250 mm (TA-SU-307/TEL7/TELEMA7)



Calibration of gauge bars  
(TELEMA7/TELEMN7.2)

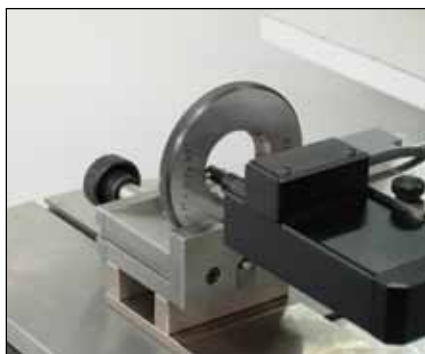

Checking of taper thread ring gauges  
(TA-MS-381/TEL75)



Checking of taper thread plug gauges  
(TA-MS-381/TEL75)

# LABCONCEPT Nano

## APPLICATIONS

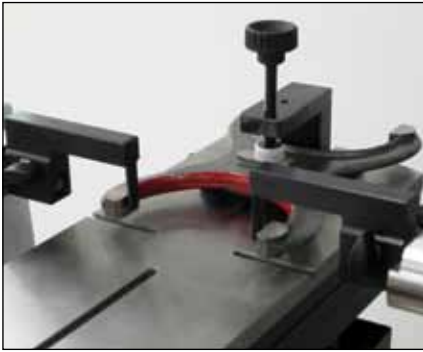

Calibration of snap gauges  
(TEL16.1/TEL14N)

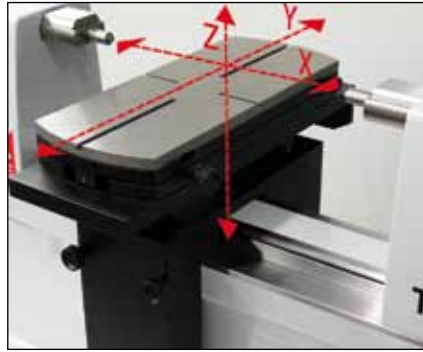

CNC-controlled measurement with  
automatic reversal point search.



Anti-vibration table (optional)



Integrated temperature compensation  
system TempComp

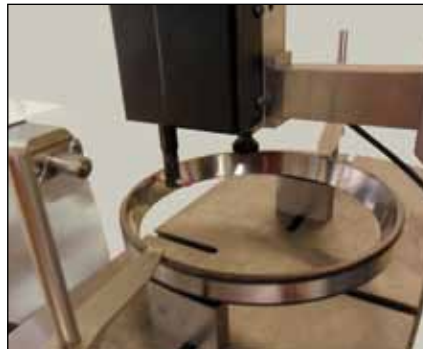

CNC controlled internal taper ring  
measurement



CNC controlled external taper ring  
measurement



CNC controlled internal measurement  
of a bearing ring



CNC controlled external  
measurement of a bearing ring



Calibration of a specific gauge