

TVM



TVM

INTRODUCTION

The TVM instruments are perfect for height measurements and scribing work and reliable in all kinds of workshop conditions. The result of an unique, compact design of the instrument is great mobility and extreme stability.

Because of its advanced measuring system, the self-contained working time of the TVM is one year. Therefore it can be used for multiple applications in the workshop area. The simplicity of manipulation allows constant change of the user without any time-consuming training.

The success of the TVM among competitive gauges is outstanding. More than 14'000 instruments are in use worldwide.

Three models are available: with application range from 300 to 1000 mm. A large range of accessories for all kinds of measuring applications is available.

ROBUST AND COMPACT CONSTRUCTION

PERFECT FOR USE IN PRODUCTION AREA

ACCURATE AND RELIABLE MEASUREMENTS





USER FRIENDLY

OPTO-RS232 DATA OUTPUT

RECHARGEABLE BATTERY PACK

TWO MODELS: CAST IRON BASE OR A GRANITE BASE

DESCRIPTION

-  Surfaces
-  2 references
-  Internal/external diameters
-  Tolerances
-  Min/Max/Delta

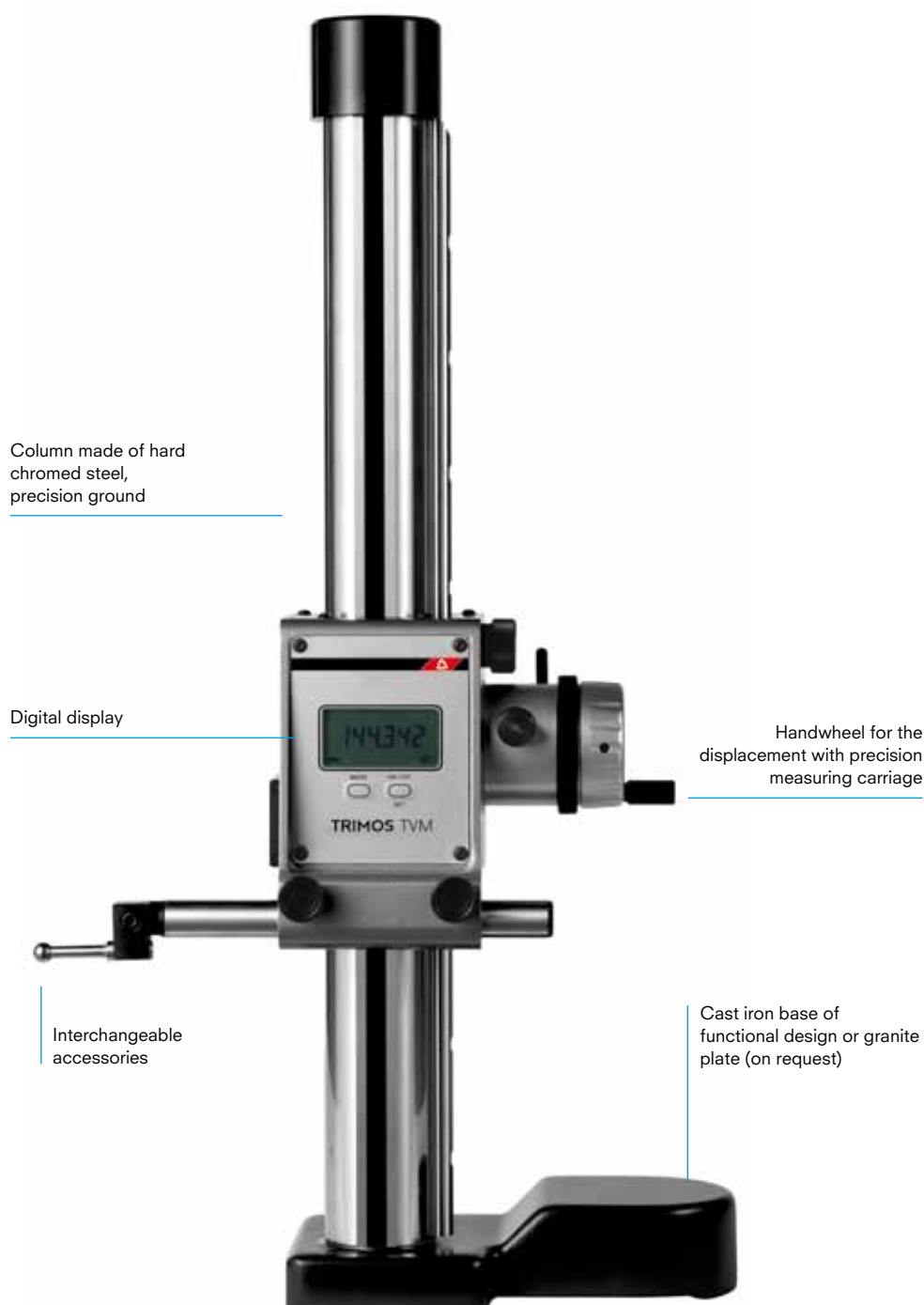

TVM

DISPLAY / SOFTWARE

The clearly defined functions of the display unit allow to collect all height measuring values.

MIN/MAX FUNCTION INDICATOR

2 REFERENCES

END OF BATTERY LIFE WARNING INDICATION

PRESET SELECTION

MEASURING UNIT (MM/IN) INDICATOR

TOLERANCE MODE INDICATOR

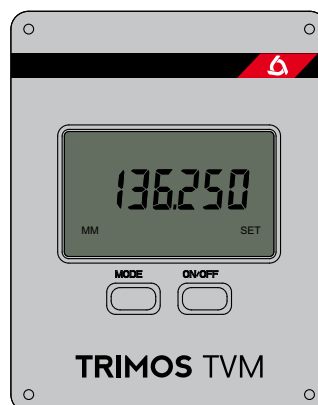

sylvac system



TECHNICAL SPECIFICATIONS

TVM		302	602	1002
Measuring range	mm (in)	320 (12)	620 (24)	1020 (40)
Max. permissible errors ¹⁾	mm	0.02	0.03	0.04
Repeatability (2s) ¹⁾	mm		0.005	
Frontal squareness deviation	mm	0.02	0.03	0.03
Resolutions	mm (in)	0.01/0.001 (.0005/.00005)		
Measuring force	N		3	
Max. manual carriage displacement speed	mm/s		1500	
Autonomy	h		2000	
Data output			Opto RS232	
Operational temperature	°C		+10 ÷ +40	
Temperature of storage	°C		-10 ÷ +40	
Weight (cast iron base)	kg	6	10	24
Weight (granite base)	kg	14	18	

¹⁾ Values valid with measuring insert and holder (TVM1/1.1/2) at temperature of 20 ± 0.5°C and relative humidity of 50 ± 5%.

DIAGRAM

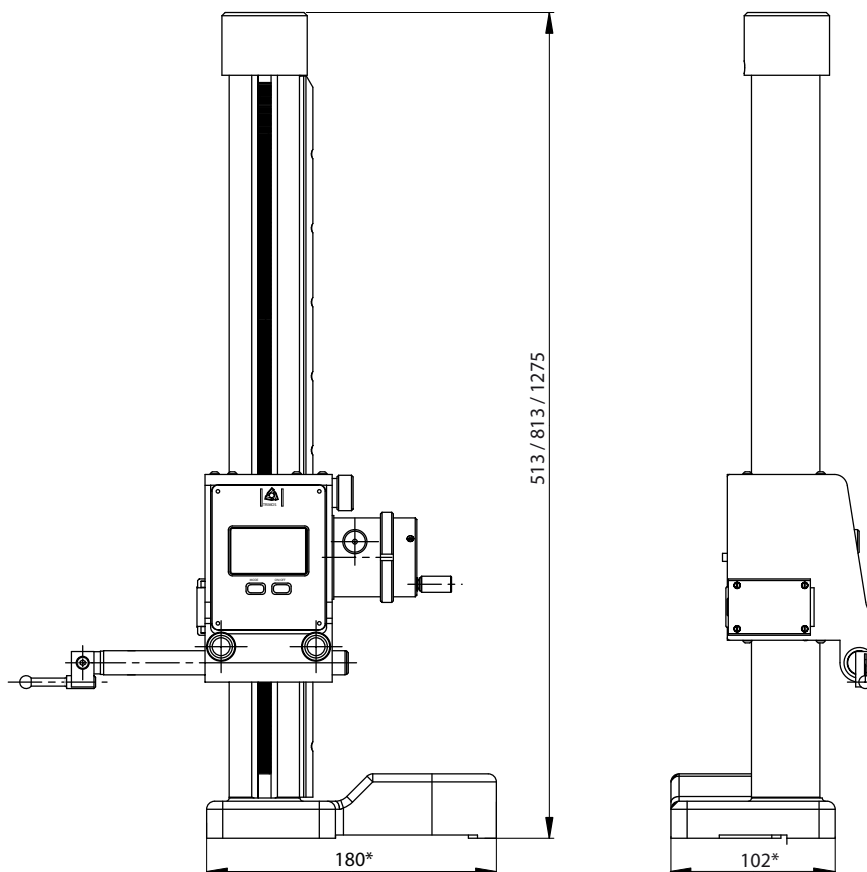

STANDARD INSTRUMENT

The TVM instruments are supplied as follows:

TVM 300- 600	TVM1000
Instrument according to specifications	Instrument according to specifications
Measuring insert and holder (TVM1 / 1.1 / 2)	Measuring insert and holder (TVA1)
Lithium battery, 3 V (BAT-TVM.OPTO)	Lithium battery, 3 V (BAT-TVM.OPTO)
Protection cover (TVM.HO300/600)	User's manual (750 50 0018 03)
User's manual (750 50 0018 03)	Test certificate
Test certificate	

CODE NUMBERS

Cast iron base	Granit base	
TVM302 700 102 10 11	TVM302G 700 102 10 14	Measuring range 300 mm
TVM602 700 102 20 11	TVM602G 700 102 20 14	Measuring range 600 mm
TVM1002 700 102 30 11		Measuring range 1000 mm

* TVM 302 and 602 only

TVM

APPLICATIONS



Height and depth measurements
(TVM1/1.1/2)



Diameter measurements (TVM4)



Measuring of centerline distances
(TVM5)



Scribing (TVM1/TVM3)



Ease of handling